

ZEMPER

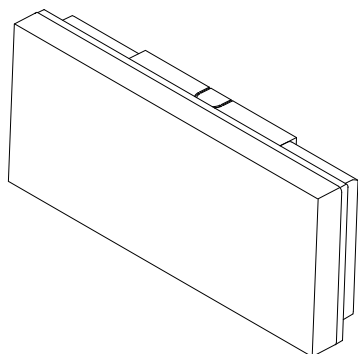

XENA
LSC / IP-42 IK-04

1 Présentation / Presentation

Conforme à EN 60598-2-22



Le luminaire est composé d'une patère de fixation et d'une enveloppe contenant l'électronique et les batteries.

The luminaire is made up of a fixing plate and a housing with electronics and batteries.

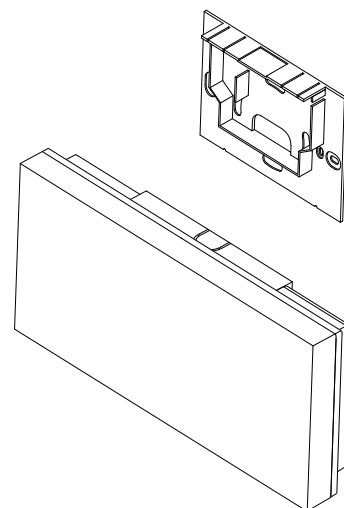

2 Installation

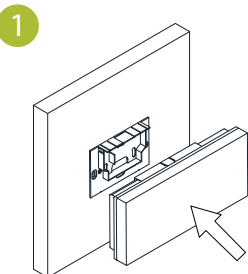

2 Montage sur surfaces irrégulières
Installation on irregular surfaces

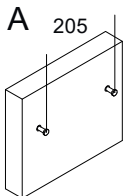
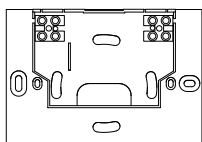

A- Vis autofiletantes 4x20 ou similaires
A- 4x20 self-threading screws or similar

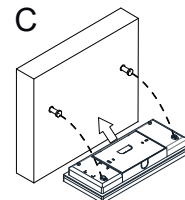
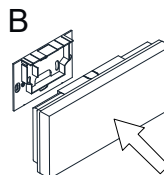

3 Démontage du bloc
Disassembly of the block

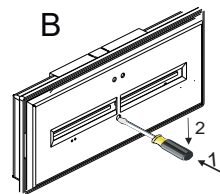
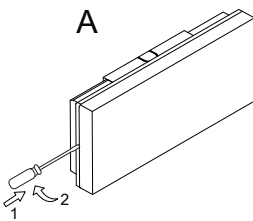
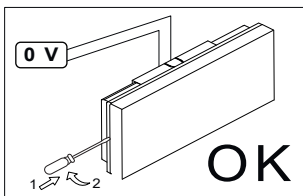
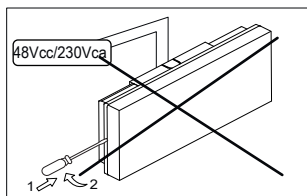

B- Appuyez avec un tournevis sur la languette.
B- Press on the tab with a screwdriver.

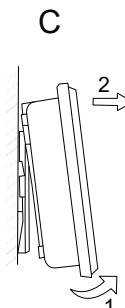

3 Raccordement / Connection

230Vca/220Vcc
110Vcc/48Vcc

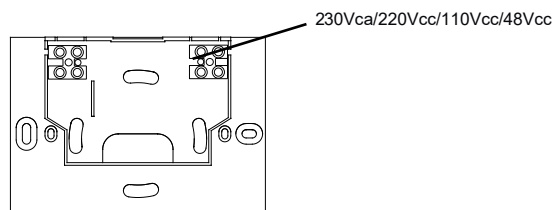
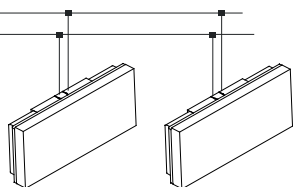

Marquage du luminaire / Luminaire labelling

Z: LSC
0: Non permanent
Non Maintained
1: Permanent
Maintained



Courbes sur demande
Curves on request

Pieces detachees / Detached pieces

	Permanent Maintained	Non permanent Non maintained	W			N° HOMOL.
LSC LXF-0448/23	45 lm	45 lm	< 2.5 VA ca/0.65W cc	12x LED 0.5W	230Vca/48Vcc	20015 / 745858
LSC LXF-4048/23	410 lm	410 lm	< 7.6 VA ca/4.0W cc	12x LED 0.5W	220Vcc/110Vcc	20016 / 745854

ATTENTION: Afin de pouvoir réaliser un entretien correct, conserver ce mode d'emploi. La source lumineuse de ce luminaire n'est pas remplaçable; lorsque la source lumineuse atteint sa fin de sa vie, le luminaire entier doit être remplacé
CAUTION: In order to be able to carry out correct maintenance, keep these instructions for use. The light source of this luminaire is not replaceable; when the light source reaches the end of its life, the entire luminaire must be replaced

**POUR TOUS RESEIGNEMENTS TECHNIQUES
APPELEZ AU +333.85.34.66.20**